

INSTALLATION AND OPERATION

Mod. Vigilec mini
(V1N)



Mod. Vigilec mono
(V1M)



Pump controller and protection for one pump
Multicontrol

Main features

- An all-in-one control and protection unit for any pump.
- Multicontrol.
- Vigilec mini: Three-phase. 230/400 V~. Direct-on-line starting (DOL).
- Vigilec mono: Single-phase 230V~. Direct-on-line starting (DOL).
- Protection against connection failure to the pump.
- Protection against overvoltage.
- Protection against overload.
- Protection against underload.
- Protection against phase failure (Vigilec mini).
- Stormproof.
- Protection against dry running with 3 possible configurations:
 - 1) TWO PROBES: low and high level.
 - 2) ONE PROBE: low level only.
 - 3) Underload: WITHOUT PROBES
 In case 2 and 3, restarting after 15 min.
- Adjustable OVERLOAD and UNDERLOAD electronic relays. Alarm trip in 7 s. (overload) or in 4 s. (underload).
- Protection against pump jamming during long rest periods (only in AUTO mode).
- Guaranteed against incorrect connections.
- Remote control output admitting 6 to 400 V~/V= contact or voltage.
- All control devices in low voltage.
- Selection MAN-0-AUT by push-buttons.
- MAIN SUPPLY led, PUMP RUNNING led, WATER LEVEL ALARM led, OVERLOAD and UNDERLOAD leds.
- Reset push-button.
- General alarm output relay.
- Wide diameters range and high protection cable glands.

Common applications

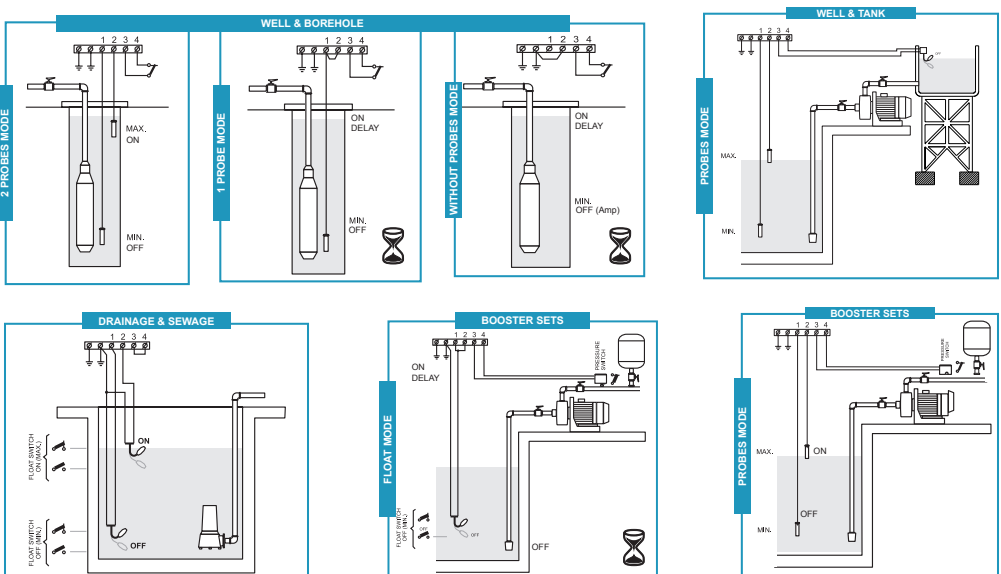

Front configuration

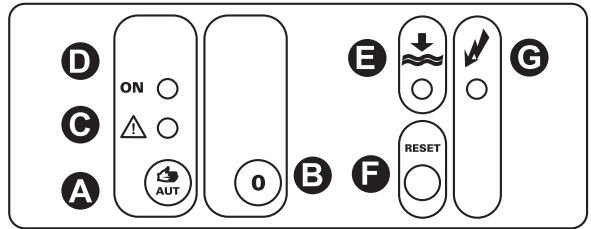

A START button:

AUTOMATIC mode (green circle Led ON): press the button and the unit will work automatically with the established controls and protections.

MANUAL mode (green circle Led flashing): holding down the button more than 4 seconds, the pump is forced to start running. The overload and underload motor protections are on in this mode. By releasing the button, the pump stops immediately and the device goes back to the AUTOMATIC mode.

B STOP (“0”) button: the unit stops the motor and blocks the re-start. If voltage failure occurs, the established operation mode remains memorized, continuing in the same mode (STOP-AUTO) once the voltage is restored.

C Red Led: MOTOR ALARM.

- Led flashing: re-start time after detection of motor alarm (overload: 7 seconds, underload: 4 seconds).
- Led on: OVERLOAD ALARM.
- Led on flashing each 5 seconds: UNDERLOAD ALARM.

D Green Led: **MOTOR RUNNING** .

E Orange Led: **LOW LEVEL**. Orange on: lack of water (2 probes mode). ORANGE FLASHING: re-start time of 15 minutes after a lack of water (1 probe with delayed start or without probes mode).

F **RESET** button: Re-starts the unit after an alarm for OVERLOAD or UNDERLOAD or stops the LACK OF WATER time delaying.

G SUPPLY VOLTAGE Green Led: it lights when there is a supply voltage.

Internal configuration

Mod. Vigilec mono

- A Control fuse (0,1A).
- B Current transformer.
- C Power relay.
- D Flat cable connector.
- E Minimum current adjustment (Amp. min).
- F Maximum current adjustment (Amp. max).
- G Control terminal blocks.
- H Capacitor housing (submersible pumps).
- I Main supply cable gland.
- J Motor cable gland.
- K Probes and earth cable gland.
- L Remote / external alarm cable gland.

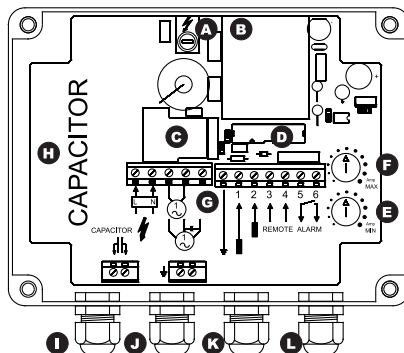

Mod. Vigilec mini

- A Circuit breaker.
- B Running motor contactor.
- C Control fuses and voltage selection (0,1 A).
- D Current transformer.
- E General alarm output relay.
- F Flat cable connector.
- G Underload adjustment (Amp. min).
- H Overload adjustment (Amp. max).
- I Control terminal blocks.
- J Main supply cable gland.
- K Motor cable gland.
- L Probes and earth cable gland.
- M Remote /external alarm cable gland.

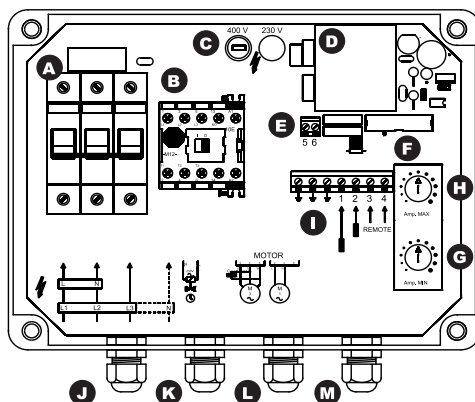

Installation

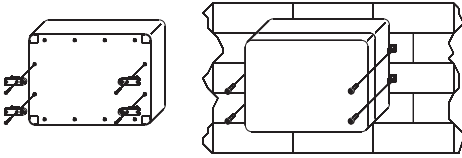

Open unit and move up the top to facilitate the connection and adjustment unit.

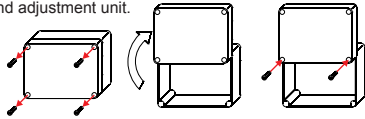

There are 4 fixing points for the wall mounting of the unit, located at the corners. As an option you can drill the enclosure in these points and screw it on the wall or on a support.



If you wish you can install external clevis for wall fixing.

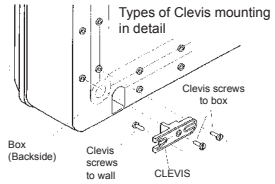

Mod. Vigilec mono

Single phase supply

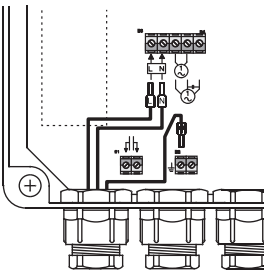

Single phase motor output

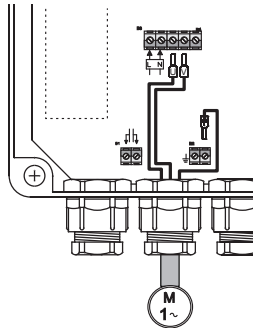

Single phase motor output + capacitor

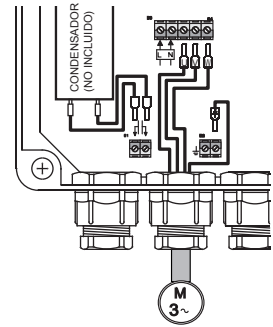

Mod. Vigilec mini

Three phase supply

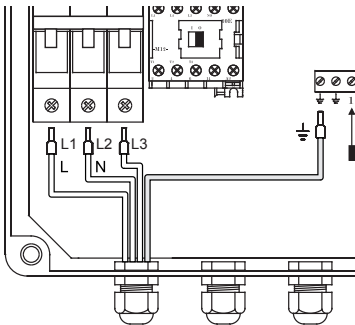

Three phase motor output

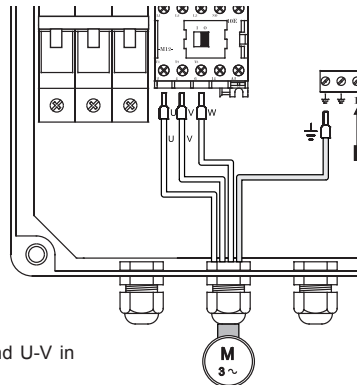

In single phase installation wire L-N in the input and U-V in the output

Probes installation

The wires must be insulated. The maximum length for probes wiring is 200 mts. and the minimum section is 0,5 mm².

A CORRECT EARTH CONNECTION is essential for the effective operation of the level control. It is recommended to connect the earth wire to any point of the pipe. A third probe submerged at the bottom of the recipient is required if the tank is insulated (concrete fiber, glass fiber and plastics in general).

Two probes

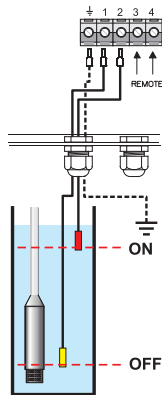

One probe

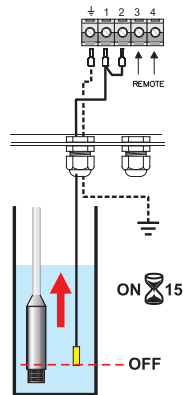

Without probes

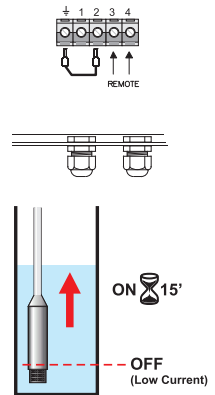

Place the probe at least some centimeters higher than the pump intake.

REMOTE connection

The REMOTE terminals ("3" y "4") can be connected to a remote device such as: radio remote control, pressure switch, float switch, irrigation controller, time switch or a power supply (6 to 400 V~ / V=). This input is protected against incorrect wiring.

A jumper must be placed over Terminal blocks "3" and "4" if not used.

Irrigation systems: we recommend to use this unit in *1 probe mode* in applications with irrigation controller or other control devices .

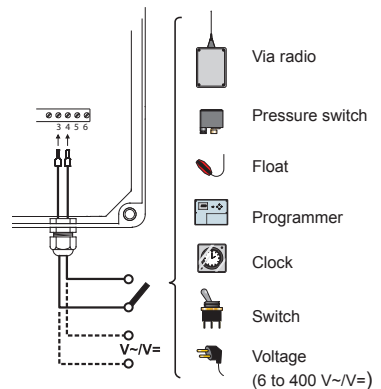

Unit operation

TWO PROBES

The pump starts when the water level exceeds the high level probe (orange led off), and stops when the water level descends below the low level probe (orange led on).

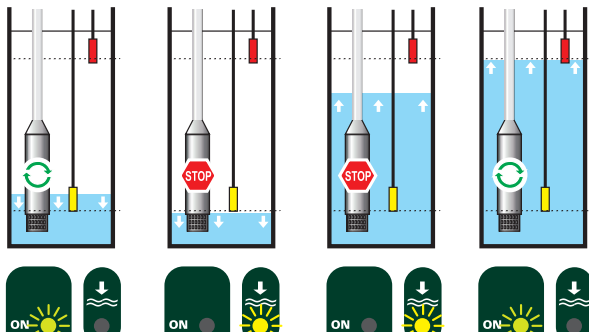

ONE PROBE

When the water level descends below the low level probe, the pump stops. If this level is recovered in less than 10 seconds, the unit thinks that we are working in "one probe" mode, so it will not re-start the pump until the end of the 15 minutes re-start time, during when the orange led will flash.

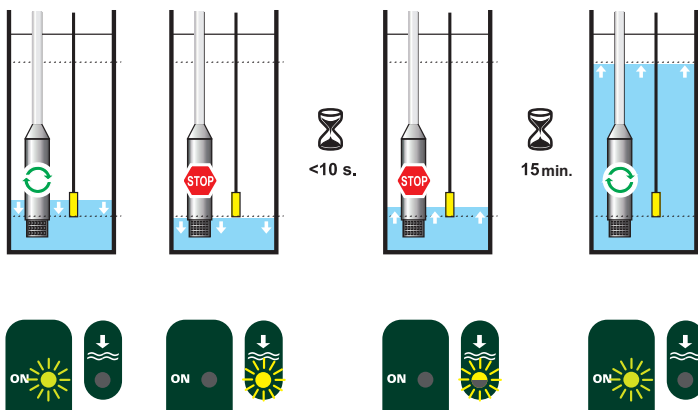

WITHOUT PROBES

A correct minimum current adjustment is essential. (see section "CURRENT ADJUSTMENTS")

When the level approaches the pump intake, the effort done by the pump decreases. The unit uses the motor as sensor: when this one decreases the effort, the intensity consumed decreases. This detection will stop the pump after a time delay of 4 s., during these seconds the alarm pilot will flash.

The pump will automatically start after a pre-defined time of 15 minutes (during this period the low level led will flash). If we press the RESET button, the time delay will be cancelled and the pump will start.

If in less than a minute of operation, the unit stops again the pump, the underload alarm will trip due to motor failure (red led flashing). It will be necessary to press RESET to restart the unit.

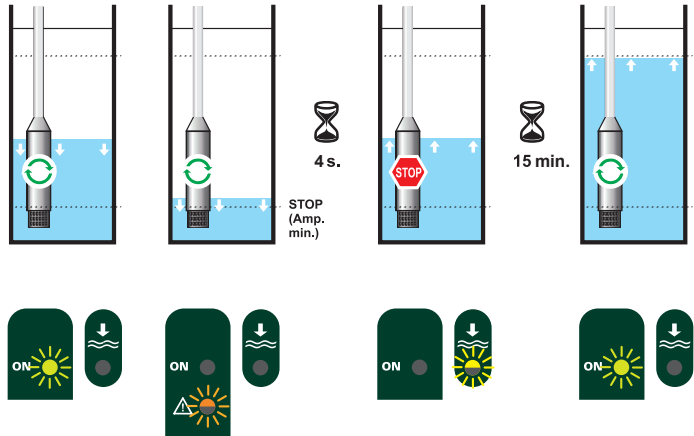

REMOTE (Only automatic mode)

The REMOTE control terminal blocks, "3" y "4, can be used to start and stop the pump from an external device. If the level led is off (correct level), when we close a contact connected to this input (float switch, pressure switch, time switch, radio remote control, switch etc) the pump will start and if we open it the pump will stop. We can also apply a voltage to this input from 6 to 400V~/V= (irrigation controller, presscontrol, etc) to start the pump or remove it to stop the pump.

Alarm output (terminals 5 y 6)

The contact will be closed when the pump stops due to thermal failure.

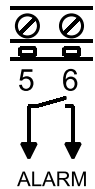

Pumps anti-jamming

If the pump is in automatic mode, the unit will activate the motor during 1 second every 23 hours of inactivity, preventing the jamming and the deterioration due to long rest periods.

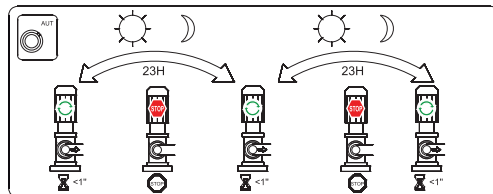

Current adjustments



LITH ON

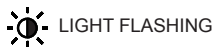

LIGHT FLASHING



LIGHT OFF

OVERLOAD adjustment (maximum current)

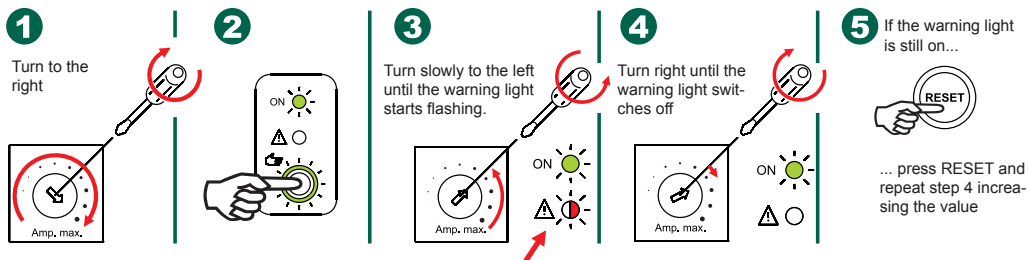

UNDERLOAD ADJUSTMENT (minimum current)

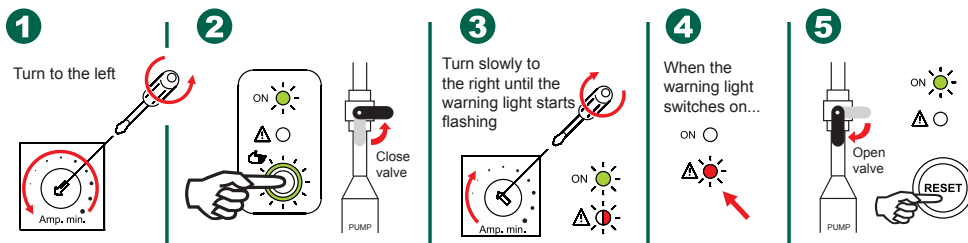

N.B. 1: If you can't close the valve to do this adjustment, turn the thumbwheel to the right until the light flashes and go back a 25%.

N.B. 2: To deactivate the underload protection, turn the thumbwheel totally to the left.

Specifications

	Vigilec mono (V1M)	Vigilec mini (V1N)
Supply voltage	230 V~	230/400 V~ (selectable)
Admissible voltage variation	±20% (>30%: auto power-off)	±20% (>30%: auto power-off)
Maximum intensity	18 Amp AC3	12 Amp AC3 (16 or 23 a/model)
Overload adjustment (Amp. max)	1-18 Amp	1-12 Amp (16 or 23 a/model)
Underload adjustment (Amp. min)	1-18 Amp	1-12 Amp (16 or 23 a/model)
Overload trip time	7 s	7 s
Underload trip time	4 s	4 s
Re-start time	15 minutes (fixed)	15 minutes (fixed)
Capacitor maximum capacity	80 µF (50 µF inside the equipment)	-
Probes operating voltage	24 V~	24 V~
Probes sensitivity	9 KΩ	9 KΩ
Remote control connection	Contact or voltage 6 to 400 V~/V=	Contact or voltage 6 to 400 V~/V=
Alarm output contact	AC1 : 2 A / 250 V~ AC11 : 1 A / 230 V~	AC1 : 2 A / 250 V~ AC11 : 1 A / 230 V~
Control terminal blocks	4 mm ²	4 mm ²
Mounting	Wall mounting with fixing points	Wall mounting with fixing points
Size (mm)	200 x 150 x 80	255 x 195 x 95
Weight	850 g	1,5 Kg
Working temperature	-10 + 55 °C	-10 + 55 °C
Protection	IP56	IP56



EC DECLARATION OF COMPLIANCE WITH THE "LOW VOLTAGE" & "ELECTROMAGNETIC COMPATIBILITY" DIRECTIVES.

TOSCANO LINEA ELETTRONICA, S.L. declares that the equipment described in this manual complies with the provisions of the modified "LOW VOLTAGE" directive (Directive DC 2004/108/CE) and with the modified "ELECTROMAGNETIC COMPATIBILITY" directive (Directive DC 2006/95/CE) and with national legislation based upon them. It also complies with the provisions of the following European standards and draft standards:

NF EN 60.439-1 / EN 50.081-1 / EN 50.082-2 .

Troubleshooting

Problem	Cause	Solution
<ul style="list-style-type: none"> The equipment does not work and the voltage light is off even when the system is connected to a power source. 	<ul style="list-style-type: none"> Control fuse is burned out. Excessive power voltage. Wrong input connection (Vigilec Mini). Phase failure (Vigilec Mini). 	<ul style="list-style-type: none"> Replace the corresponding fuse. Measure and check the power voltage. Connect correctly. Check phases.
<ul style="list-style-type: none"> The system is working but the contactor does not activated. 	<ul style="list-style-type: none"> Voltage selection error (Vigilec mini). 	<ul style="list-style-type: none"> Verify voltage selection.
<ul style="list-style-type: none"> Pump alarm trips. 	<ul style="list-style-type: none"> Overcurrent adjustment (Amp. max/Amp. min) too low or critical. Motor not connected. Input phase failure (Vigilec mini). Abnormal excessive motor consumption. Low motor consumption <0,5A. 	<ul style="list-style-type: none"> Check motor consumption and adjust again the intensity. Connect the motor. Check the three supply phases. Check the motor. The motor is overloaded. Check pump (there is no water in the pump intake, the pipe is clogged, etc.).
<ul style="list-style-type: none"> Level control doesn't work correctly. 	<ul style="list-style-type: none"> High and low level probes are reversed. Wrong ground connection. Cut wires (Probes/Remote). 	<ul style="list-style-type: none"> Place the probes in the correct position. Check the ground connection. Check the wires continuity.

INSTRUCCIONES DE INSTALACION Y USO
NOTICE D'INSTALLATION ET DE MISE EN SERVICE
INSTRUÇÕES DE INSTALAÇÃO E USO
MANUALI DI INSTRUZIONE
INSTALLATIONSHINWEISE UND INBETRIEBNAHME
HANDLEIDING VOOR INSTALLATIE EN GEBRUIK
ΕΓΚΑΤΑΣΤΑΣΗ ΚΑΙ ΧΡΗΣΗ
KURULUM VE KULLANIM
ASENNUS JA KÄYTTÖ
ОБЛАСТЬ ПРИМЕНЕНИЯ И УСТАНОВКА
مادختس ال او تي بشتلا
安裝和使用

www.vigilec.com

